



EUROCONNECTION

collegamenti di sistemi

FANUC

Compatible Cables and Accessories



Specifiche dei Connettori 18-10 e 22-22	18-10 and 22-22 Connector Specificationspag	2
Viste Motori - Uscita cavi di Potenza	<i>Motor Views - Exit Power Cables</i>	" 3
Specifiche Tecniche - cavi di Potenza	<i>Technical Specifications - Power Cables</i>	" 3
Cavi di Potenza	Power cablespag	4
Cavi di Potenza	<i>Power Cables</i>	" 4
Prolunghe per cavi di Potenza	<i>Extension Power cables</i>	" 12
Cavi per Freno	Brake cablespag	16
Cavi per Freno	<i>Brake cables</i>	" 16
Prolunghe per Freno	<i>Extension Brake cables</i>	" 17
Cavi per Ventola	Fan cablespag	18
Cavi per Feedback	Feedback cablespag	19
Cavi per Feedback	<i>Feedback cables</i>	" 19
Prolunghe per cavi Feedback	<i>Extension Feedback cables</i>	" 20
Cavi per I/O Link	I/O Link cablespag	22
Cavi per I/O Link	<i>I/O Link cables</i>	" 22
Prolunghe per cavi I/O LINK	<i>Extension I/O Link cables</i>	" 23
Cavi per Quadro Elettrico	Electrical Cabinet cablespag	24
Cavi per Pannello Operatore	Operator's Panel cablespag	28

Fanuc article descriptions into the catalogue are registered trademarks of Fanuc, and are for reference purposes only



EUROCONNECTION
collegamenti di sistemi

18-10 AND 22-22 CONNECTOR SPECIFICATIONS

SPECIFICHE dei CONNETTORI 18-10 e 22-22

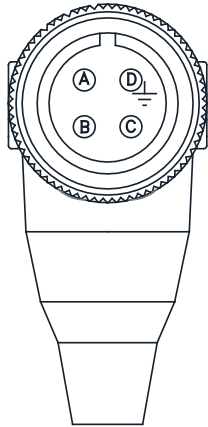

Standard
0°

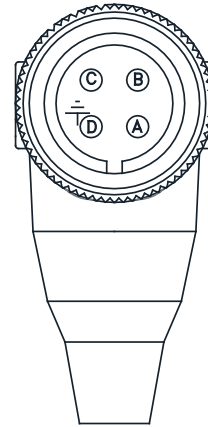
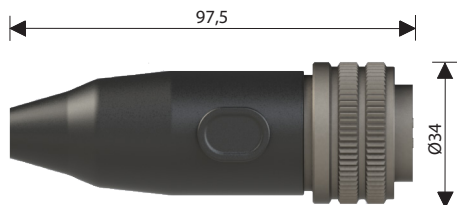
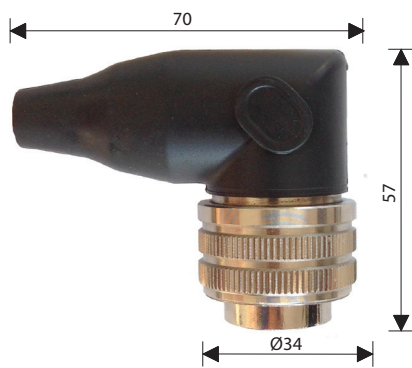

-V
180°

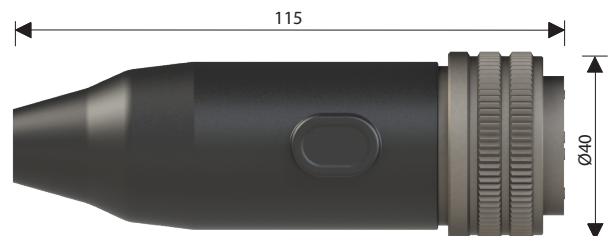
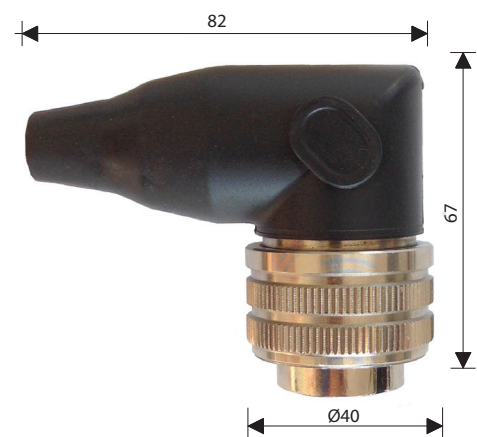

18-10 AND 22-22 CONNECTOR SPECIFICATIONS

SPECIFICHE dei CONNETTORI 18-10 e 22-22

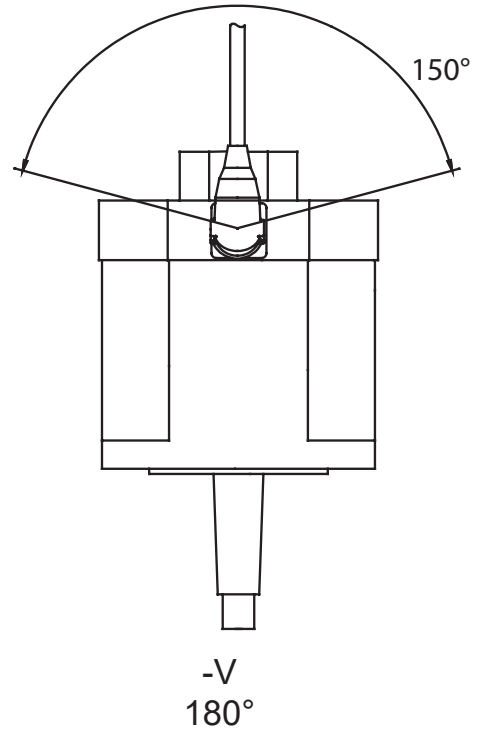
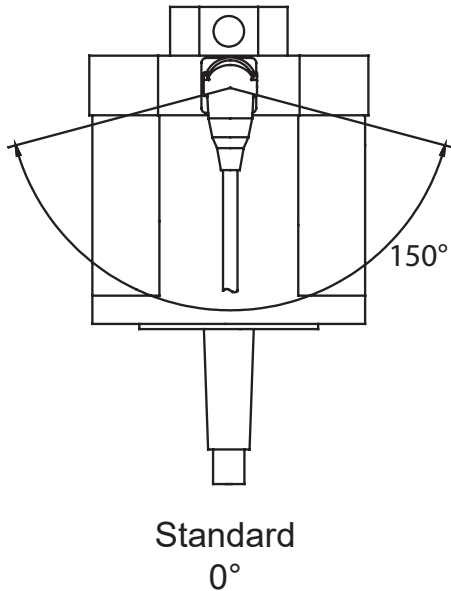

SPECIFICHE TECNICHE	TECHNICAL SPECIFICATIONS	18-10	22-22
Normativa di riferimento	Reference standards	MIL-C-5010	MIL-C-5010
Grado di protezione	Protection Class	IP67 (se accoppiato)	IP67 (if mated)
Range di Temperatura	Temperature Range	-40°C / +100°C	-40°C / +100°C
Corrente Nominale	Nominal Currents	23 A	46 A
Sezione Massima Conduttori	Maximum Section Conductor	3 mmq	6 mmq
Tensione Nominale	Nominal Voltage	500 V	500 V
Resistenza di contatto	Contact Resistance	≤ 5mΩ	≤ 5mΩ

ORIENTAMENTO	ORIENTATION
--------------	-------------

L'orientamento dell'uscita del cavo può essere personalizzata, secondo le esigenze del cliente.

The orientation of exit cable can be customized, in relation to satisfy a custom.

In alto sono riportate le configurazioni possibili, la lettera -V, è contenuta nella descrizione del codice.

In top, are reported the possible configurations, with a letter -V, is contained in a description of Reference Number.

SPECIFICHE MECCANICHE	MECHANICAL SPECIFICATION
Resistenza alle vibrazioni	Vibration resistance
Resistenza agli shock	Shock resistance

Frequency: 10-500Hz, single amplitude 0,6mm, acceleration: 98m/sq, 3 hours over 3 axes, with connector mated

Acceleration: 490m/sq, 11 ms, Half sine wave, Waveform, 3 runs in 3 axes, with connector mated

MATERIALI	MATERIALS	18-10 and 22-22
Struttura	Cabinet	ZnAL4Cu1 (tratt. al Ni)
Ghiera	Coupling Nut	AL 2011 (tratt. al Ni)
Filettatura	Locking / Thread	1,1250 - 18 UNEF
Supporto Isolante	Insulation Holder	ZnAl4Cu1 (tratt. al Ni)
Corpo Isolante	Insulation Body	In accord to UL94V0
Contatti	Contacts	(tratt. al Ag)
Guarnizioni	Sealings	NBR
Anelli Elastici	Housing Rings	AlSi302
Schermatura	Shielding	CuZn39Pb3
Copertura di sovrastampaggio	Moulding Cover	Poliammide / Polyamide In accord to UL94V0



DIN EN 61984 - VDE 0627

Grado di Inquinamento	Pollution Degree	3 (IEC 60060-1)
Categoria di Sovratensione	Over Voltage Category	II
Utilizzo ad Altitudine Massima	Max Operation Altitude	2000 m

FANUC COMPATIBLE - POWER CABLES

COMPATIBILE FANUC - CAVI DI POTENZA

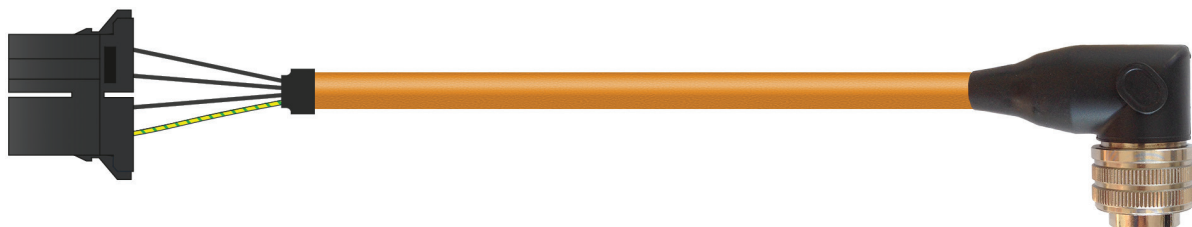

Reference Number <i>Codice Articolo</i>	Description <i>Descrizione</i>	Application <i>Applicazione</i>
1-000-002-1-001	LX660-4078-T451/LxRx3	FIXED
1-000-002-2-001	LX660-4078-T451/LxRx3	DYNAMIC
1-000-002-1-002	LX660-4078-T451/LxRx3-V	FIXED
1-000-002-2-002	LX660-4078-T451/LxRx3-V	DYNAMIC

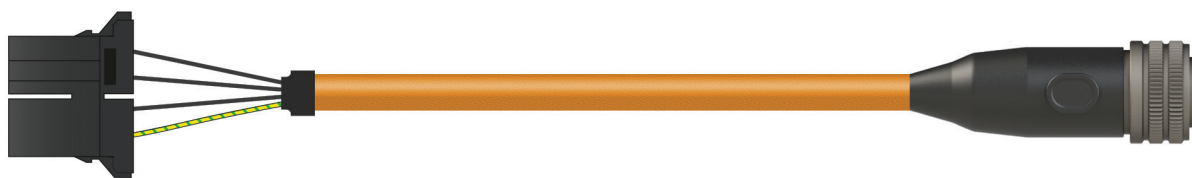

Reference Number <i>Codice Articolo</i>	Description <i>Descrizione</i>	Application <i>Applicazione</i>
1-000-002-1-005	LX660-4078-T450/LxRx3	FIXED
1-000-002-2-005	LX660-4078-T450/LxRx3	DYNAMIC

FANUC COMPATIBLE - POWER CABLES

COMPATIBILE FANUC - CAVI DI POTENZA

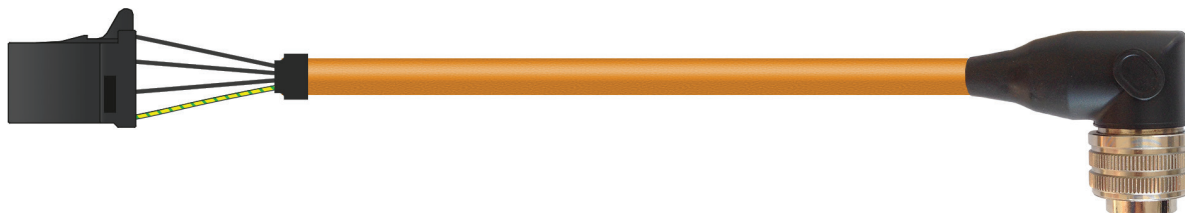

Reference Number <i>Codice Articolo</i>	Description <i>Descrizione</i>	Application <i>Applicazione</i>
1-000-002-1-006	LX660-4078-T453/LxRx3	FIXED
1-000-002-2-006	LX660-4078-T453/LxRx3	DYNAMIC
1-000-002-1-007	LX660-4078-T453/LxRx3-V	FIXED
1-000-002-2-007	LX660-4078-T453/LxRx3-V	DYNAMIC



Reference Number <i>Codice Articolo</i>	Description <i>Descrizione</i>	Application <i>Applicazione</i>
1-000-002-1-010	LX660-4078-T452/LxRx3	FIXED
1-000-002-2-010	LX660-4078-T452/LxRx3	DYNAMIC

FANUC COMPATIBLE - POWER CABLES

COMPATIBILE FANUC - CAVI DI POTENZA

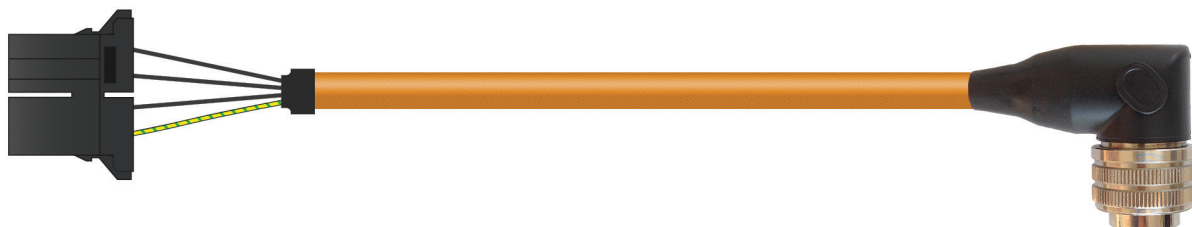

Reference Number <i>Codice Articolo</i>	Description <i>Descrizione</i>	Application <i>Applicazione</i>
1-000-002-1-016	LX660-8077-T451/LxRx3	FIXED
1-000-002-2-016	LX660-8077-T451/LxRx3	DYNAMIC
1-000-002-1-017	LX660-8077-T451/LxRx3-V	FIXED
1-000-002-2-017	LX660-8077-T451/LxRx3-V	DYNAMIC

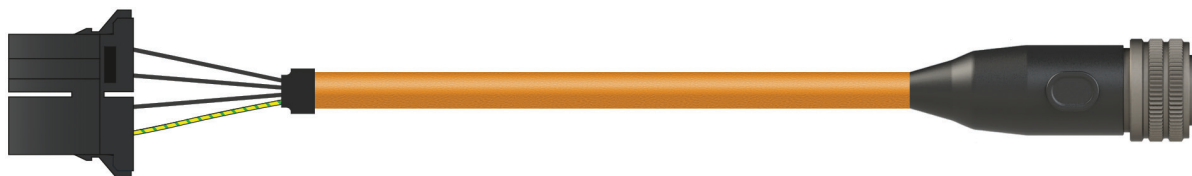

Reference Number <i>Codice Articolo</i>	Description <i>Descrizione</i>	Application <i>Applicazione</i>
1-000-002-1-020	LX660-8077-T450/LxRx3	FIXED
1-000-002-2-020	LX660-8077-T450/LxRx3	DYNAMIC

FANUC COMPATIBLE - POWER CABLES

COMPATIBILE FANUC - CAVI DI POTENZA

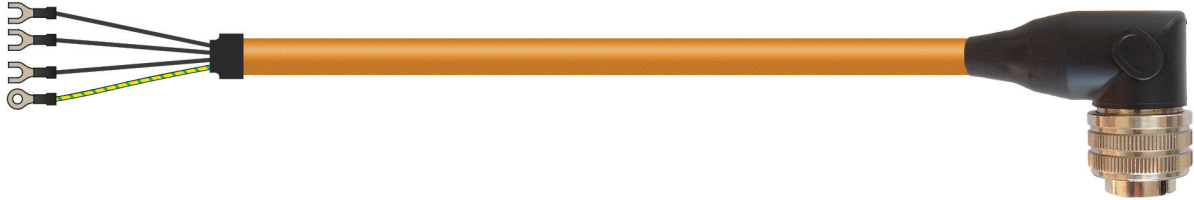

Reference Number <i>Codice Articolo</i>	Description <i>Descrizione</i>	Application <i>Applicazione</i>
1-000-002-1-021	LX660-8077-T453/LxRx3	FIXED
1-000-002-2-021	LX660-8077-T453/LxRx3	DYNAMIC
1-000-002-1-022	LX660-8077-T453/LxRx3-V	FIXED
1-000-002-2-022	LX660-8077-T453/LxRx3-V	DYNAMIC



Reference Number <i>Codice Articolo</i>	Description <i>Descrizione</i>	Application <i>Applicazione</i>
1-000-002-1-025	LX660-8077-T452/LxRx3	FIXED
1-000-002-2-025	LX660-8077-T452/LxRx3	DYNAMIC

FANUC COMPATIBLE - POWER CABLES

COMPATIBILE FANUC - CAVI DI POTENZA

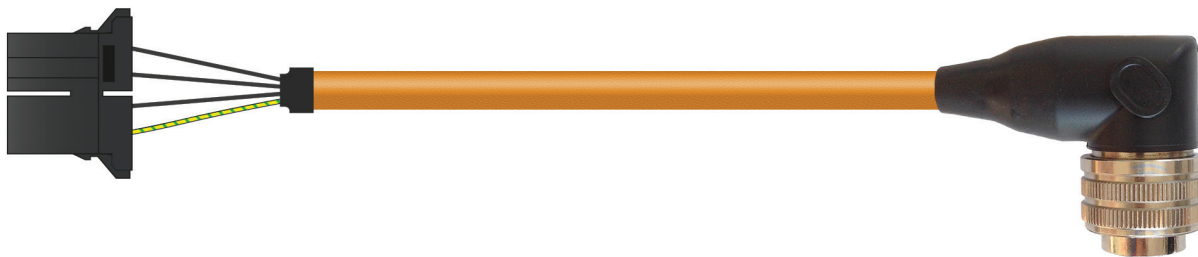

Reference Number <i>Codice Articolo</i>	Description <i>Descrizione</i>	Application <i>Applicazione</i>
1-000-002-1-011	LX660-4078-T471/LxRx3	FIXED
1-000-002-2-011	LX660-4078-T471/LxRx3	DYNAMIC
1-000-002-1-012	LX660-4078-T471/LxRx3-V	FIXED
1-000-002-2-012	LX660-4078-T471/LxRx3-V	DYNAMIC

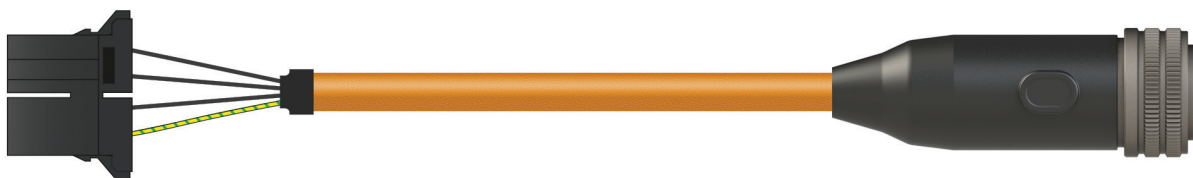

Reference Number <i>Codice Articolo</i>	Description <i>Descrizione</i>	Application <i>Applicazione</i>
1-000-002-1-015	LX660-4078-T470/LxRx3	FIXED
1-000-002-2-015	LX660-4078-T470/LxRx3	DYNAMIC

FANUC COMPATIBLE - POWER CABLES

COMPATIBILE FANUC - CAVI DI POTENZA

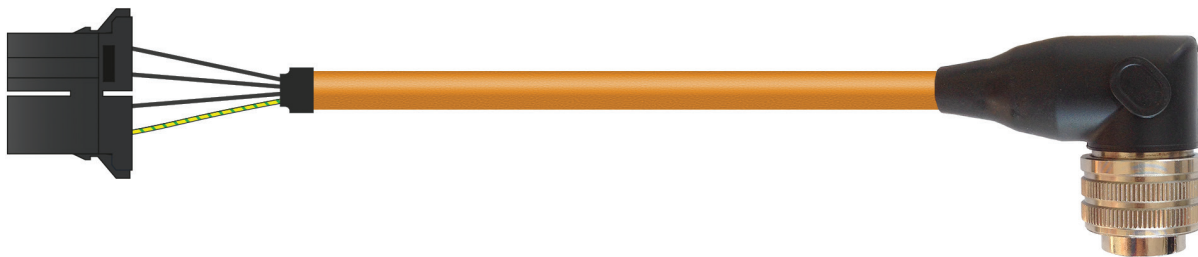

Reference Number <i>Codice Articolo</i>	Description <i>Descrizione</i>	Application <i>Applicazione</i>
1-000-002-1-031	LX660-8077-T471/LxRx3	FIXED
1-000-002-2-031	LX660-8077-T471/LxRx3	DYNAMIC
1-000-002-1-032	LX660-8077-T471/LxRx3-V	FIXED
1-000-002-2-032	LX660-8077-T471/LxRx3-V	DYNAMIC

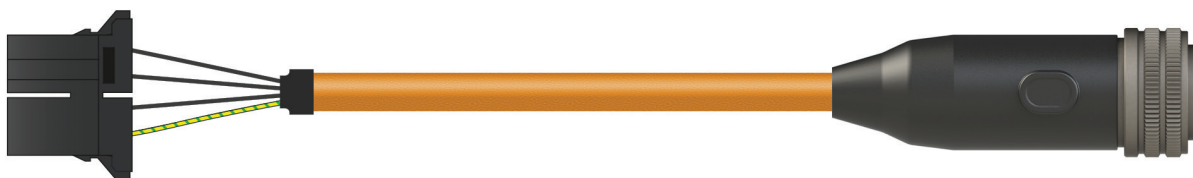

Reference Number <i>Codice Articolo</i>	Description <i>Descrizione</i>	Application <i>Applicazione</i>
1-000-002-1-035	LX660-8077-T470/LxRx3	FIXED
1-000-002-2-035	LX660-8077-T470/LxRx3	DYNAMIC

FANUC COMPATIBLE - POWER CABLES

COMPATIBILE FANUC - CAVI DI POTENZA

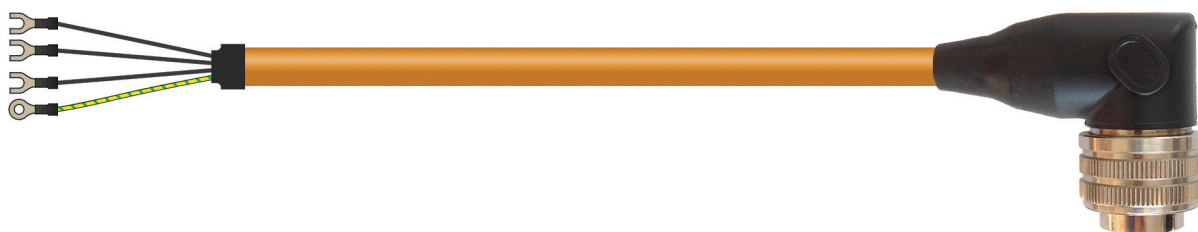

Reference Number <i>Codice Articolo</i>	Description <i>Descrizione</i>	Application <i>Applicazione</i>
1-000-002-1-036	LX660-8077-T473/LxRx3	FIXED
1-000-002-2-036	LX660-8077-T473/LxRx3	DYNAMIC
1-000-002-1-037	LX660-8077-T473/LxRx3-V	FIXED
1-000-002-2-037	LX660-8077-T473/LxRx3-V	DYNAMIC



Reference Number <i>Codice Articolo</i>	Description <i>Descrizione</i>	Application <i>Applicazione</i>
1-000-002-1-040	LX660-8077-T472/LxRx3	FIXED
1-000-002-2-040	LX660-8077-T472/LxRx3	DYNAMIC

FANUC COMPATIBLE - POWER CABLES

COMPATIBILE FANUC - CAVI DI POTENZA

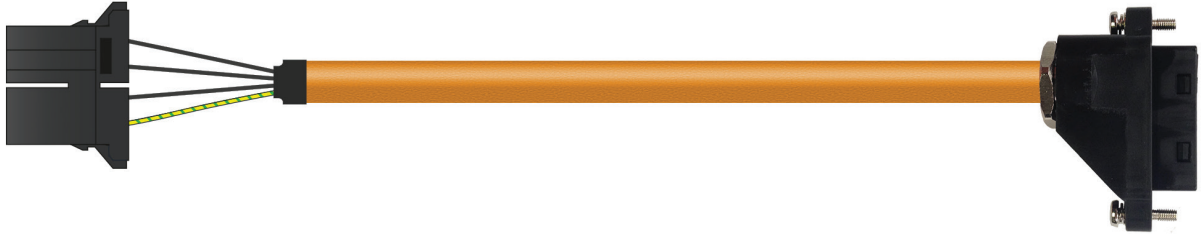

Reference Number <i>Codice Articolo</i>	Description <i>Descrizione</i>	Application <i>Applicazione</i>
1-000-002-1-258	LX660-8077-T308/LxRx3	FIXED
1-000-002-2-258	LX660-8077-T308/LxRx3	DYNAMIC

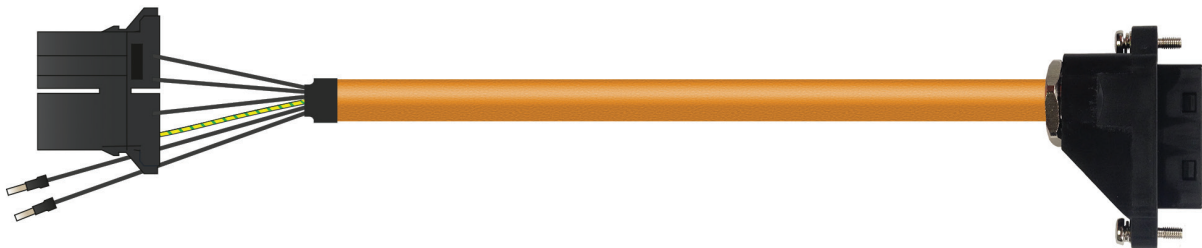

Reference Number <i>Codice Articolo</i>	Description <i>Descrizione</i>	Application <i>Applicazione</i>
1-000-002-1-212	LX660-8077-T262/LxRx3	FIXED
1-000-002-2-212	LX660-8077-T262/LxRx3	DYNAMIC

FANUC COMPATIBLE - EXTENSION POWER CABLES

COMPATIBILE FANUC - PROLUNGHE per CAVI DI POTENZA

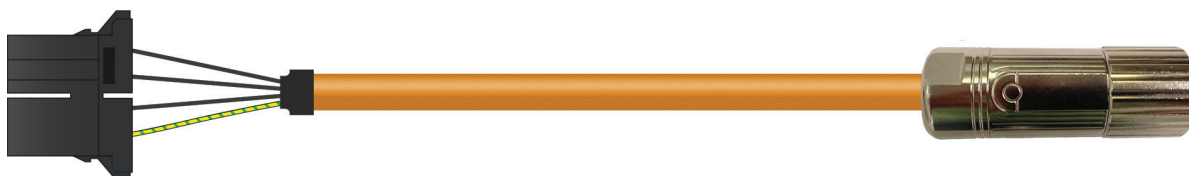

Reference Number <i>Codice Articolo</i>	Description <i>Descrizione</i>	Application <i>Applicazione</i>
1-000-002-1-245	LX660-8077-T296/LxRx3	FIXED
1-000-002-2-245	LX660-8077-T296/LxRx3	DYNAMIC



Reference Number <i>Codice Articolo</i>	Description <i>Descrizione</i>	Application <i>Applicazione</i>
1-000-002-1-246	LX660-8077-T295/LxRx3	FIXED
1-000-002-2-246	LX660-8077-T295/LxRx3	DYNAMIC

FANUC COMPATIBLE - EXTENSION POWER CABLES

COMPATIBILE FANUC - PROLUNGHE per CAVI DI POTENZA



Reference Number <i>Codice Articolo</i>	Description <i>Descrizione</i>	Application <i>Applicazione</i>
1-000-002-1-026	LX660-8077-T455/LxRx3	FIXED
1-000-002-2-026	LX660-8077-T455/LxRx3	DYNAMIC
1-000-002-1-027	LX660-8077-T455/LxRx3-V	FIXED
1-000-002-2-027	LX660-8077-T455/LxRx3-V	DYNAMIC



Reference Number <i>Codice Articolo</i>	Description <i>Descrizione</i>	Application <i>Applicazione</i>
1-000-002-1-030	LX660-8077-T454/LxRx3	FIXED
1-000-002-2-030	LX660-8077-T454/LxRx3	DYNAMIC

FANUC COMPATIBLE - EXTENSION POWER CABLES

COMPATIBILE FANUC - PROLUNGHE per CAVI DI POTENZA

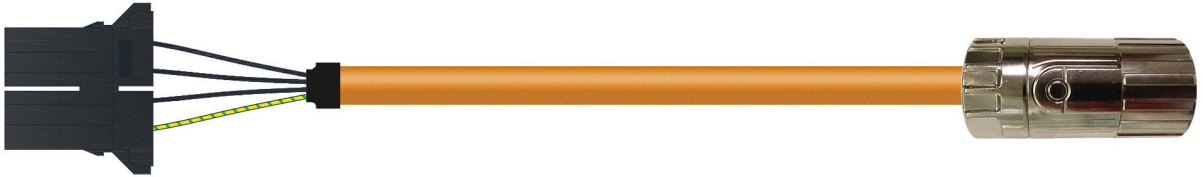

Reference Number <i>Codice Articolo</i>	Description <i>Descrizione</i>	Application <i>Applicazione</i>
--	-----------------------------------	------------------------------------

1-000-002-1-248	LX660-8077-T298/LxRx3	FIXED
-----------------	-----------------------	-------

1-000-002-2-248	LX660-8077-T298/LxRx3	DYNAMIC
-----------------	-----------------------	---------



Reference Number <i>Codice Articolo</i>	Description <i>Descrizione</i>	Application <i>Applicazione</i>
--	-----------------------------------	------------------------------------

1-000-002-1-247	LX660-8077-T297/LxRx3	FIXED
-----------------	-----------------------	-------

1-000-002-2-247	LX660-8077-T297/LxRx3	DYNAMIC
-----------------	-----------------------	---------



Reference Number <i>Codice Articolo</i>	Description <i>Descrizione</i>	Application <i>Applicazione</i>
--	-----------------------------------	------------------------------------

1-000-002-1-361	LX660-8077-T411/LxRx3	FIXED
-----------------	-----------------------	-------

1-000-002-2-361	LX660-8077-T411/LxRx3	DYNAMIC
-----------------	-----------------------	---------

FANUC COMPATIBLE - EXTENSION POWER CABLES

COMPATIBILE FANUC - PROLUNGHE per CAVI DI POTENZA

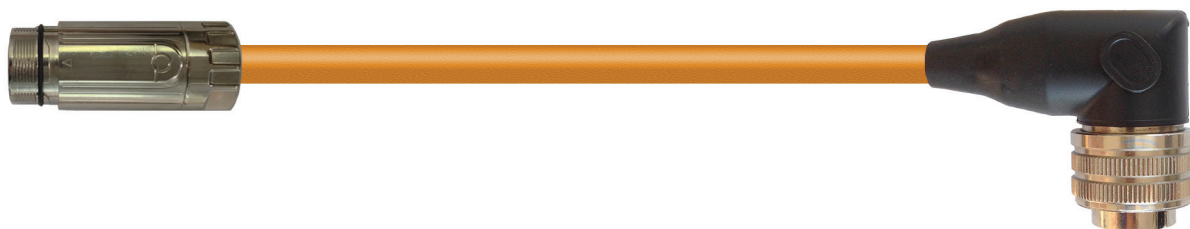

Reference Number <i>Codice Articolo</i>	Description <i>Descrizione</i>	Application <i>Applicazione</i>
1-000-002-1-041	LX660-8077-T475/LxRx3	FIXED
1-000-002-2-041	LX660-8077-T475/LxRx3	DYNAMIC
1-000-002-1-042	LX660-8077-T475/LxRx3-V	FIXED
1-000-002-2-042	LX660-8077-T475/LxRx3-V	DYNAMIC



Reference Number <i>Codice Articolo</i>	Description <i>Descrizione</i>	Application <i>Applicazione</i>
1-000-002-1-045	LX660-8077-T474/LxRx3	FIXED
1-000-002-2-045	LX660-8077-T474/LxRx3	DYNAMIC

FANUC COMPATIBLE - BRAKE CABLES

COMPATIBILE FANUC - CAVI per FRENO



Reference Number <i>Codice Articolo</i>	Description <i>Descrizione</i>	Application <i>Applicazione</i>
1-000-002-1-230	LX660-8077-T280/LxRx3	FIXED
1-000-002-2-230	LX660-8077-T280/LxRx3	DYNAMIC



Reference Number <i>Codice Articolo</i>	Description <i>Descrizione</i>	Application <i>Applicazione</i>
1-000-002-1-231	LX660-8077-T281/LxRx3	FIXED
1-000-002-2-231	LX660-8077-T281/LxRx3	DYNAMIC

FANUC COMPATIBLE - EXTENSION BRAKE CABLES

COMPATIBILE FANUC - PROLUNGHE per FRENO



Reference Number <i>Codice Articolo</i>	Description <i>Descrizione</i>	Application <i>Applicazione</i>
1-000-002-1-262	LX660-8077-T312/LxRx3	FIXED
1-000-002-2-262	LX660-8077-T312/LxRx3	DYNAMIC



Reference Number <i>Codice Articolo</i>	Description <i>Descrizione</i>	Application <i>Applicazione</i>
1-000-002-1-261	LX660-8077-T311/LxRx3	FIXED
1-000-002-2-261	LX660-8077-T311/LxRx3	DYNAMIC



Reference Number <i>Codice Articolo</i>	Description <i>Descrizione</i>	Application <i>Applicazione</i>
1-000-002-1-260	LX660-8077-T310/LxRx3	FIXED
1-000-002-2-260	LX660-4078-T310/LxRx3	DYNAMIC

FANUC COMPATIBLE - FAN CABLES

COMPATIBILE FANUC - CAVI per VENTOLA



Reference Number <i>Codice Articolo</i>	Description <i>Descrizione</i>	Application <i>Applicazione</i>
1-000-002-1-254	LX660-8077-T304/LxRx3	FIXED
1-000-002-2-254	LX660-8077-T304/LxRx3	DYNAMIC



Reference Number <i>Codice Articolo</i>	Description <i>Descrizione</i>	Application <i>Applicazione</i>
1-000-002-1-255	LX660-8077-T305/LxRx3	FIXED
1-000-002-2-255	LX660-8077-T305/LxRx3	DYNAMIC

FANUC COMPATIBLE - FEEDBACK CABLES

COMPATIBILE FANUC - CAVI per FEEDBACK

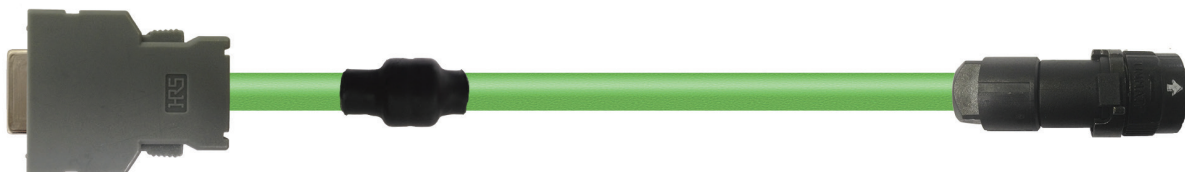

Reference Number <i>Codice Articolo</i>	Description <i>Descrizione</i>	Application <i>Applicazione</i>
1-000-002-1-596	LX660-4077-T296/LxRx3	FIXED
1-000-002-2-596	LX660-4077-T296/LxRx3	DYNAMIC

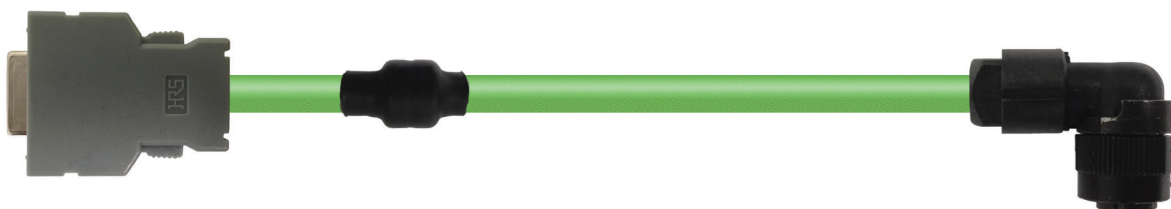

Reference Number <i>Codice Articolo</i>	Description <i>Descrizione</i>	Application <i>Applicazione</i>
1-000-002-1-597	LX660-4077-T297/LxRx3	FIXED
1-000-002-2-597	LX660-4077-T297/LxRx3	DYNAMIC

FANUC COMPATIBLE - EXTENSION FEEDBACK CABLES

COMPATIBILE FANUC - PROLUNGHE per CAVI FEEDBACK

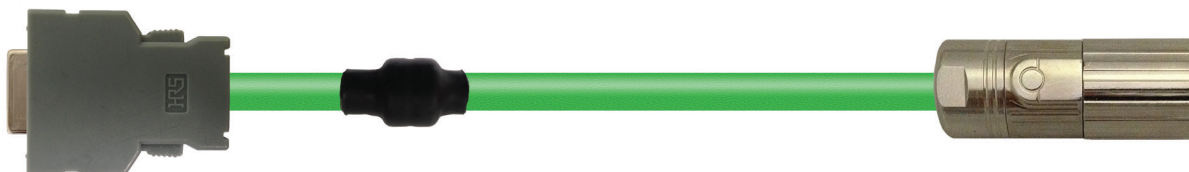

Reference Number <i>Codice Articolo</i>	Description <i>Descrizione</i>	Application <i>Applicazione</i>
1-000-002-1-604	LX660-4077-T304/LxRx3	FIXED
1-000-002-2-604	LX660-4077-T304/LxRx3	DYNAMIC



Reference Number <i>Codice Articolo</i>	Description <i>Descrizione</i>	Application <i>Applicazione</i>
1-000-002-1-641	LX660-4077-T341/LxRx3	FIXED
1-000-002-2-641	LX660-4077-T341/LxRx3	DYNAMIC

FANUC COMPATIBLE - EXTENSION FEEDBACK CABLES

COMPATIBILE FANUC - PROLUNGHE per CAVI FEEDBACK



Reference Number <i>Codice Articolo</i>	Description <i>Descrizione</i>	Application <i>Applicazione</i>
1-000-002-1-603	LX660-4077-T303/LxRx3	FIXED
1-000-002-2-603	LX660-4077-T303/LxRx3	DYNAMIC



Reference Number <i>Codice Articolo</i>	Description <i>Descrizione</i>	Application <i>Applicazione</i>
1-000-002-1-602	LX660-4077-T302/LxRx3	FIXED
1-000-002-2-602	LX660-4077-T302/LxRx3	DYNAMIC

FANUC COMPATIBLE - I/O LINK CABLES

COMPATIBILE FANUC - CAVI per I/O LINK



Reference Number <i>Codice Articolo</i>	Description <i>Descrizione</i>	Application <i>Applicazione</i>
1-000-002-1-750	LX660-2007-T010/LxRx3	FIXED
1-000-002-2-750	LX660-2007-T010/LxRx3	DYNAMIC
1-000-002-1-751	LX660-2007-T011/LxRx3	FIXED
1-000-002-2-751	LX660-2007-T011/LxRx3	DYNAMIC
1-000-002-1-752	LX660-2007-T012/LxRx3	FIXED
1-000-002-2-752	LX660-2007-T012/LxRx3	DYNAMIC
1-000-002-1-753	LX660-2007-T013/LxRx3	FIXED
1-000-002-2-753	LX660-2007-T013/LxRx3	DYNAMIC
1-000-002-1-754	LX660-2007-T014/LxRx3	FIXED
1-000-002-2-754	LX660-2007-T014/LxRx3	DYNAMIC
1-000-002-1-755	LX660-2007-T015/LxRx3	FIXED
1-000-002-2-755	LX660-2007-T015/LxRx3	DYNAMIC

FANUC COMPATIBLE - EXTENSION I/O LINK CABLES

COMPATIBILE FANUC - PROLUNGHE per CAVI I/O LINK



Reference Number <i>Codice Articolo</i>	Description <i>Descrizione</i>	Application <i>Applicazione</i>
--	-----------------------------------	------------------------------------

1-000-002-1-756	LX660-2007-T016/LxRx3	FIXED
-----------------	-----------------------	-------

1-000-002-2-756	LX660-2007-T016/LxRx3	DYNAMIC
-----------------	-----------------------	---------



Reference Number <i>Codice Articolo</i>	Description <i>Descrizione</i>	Application <i>Applicazione</i>
--	-----------------------------------	------------------------------------

1-000-002-1-757	LX660-2007-T017/LxRx3	FIXED
-----------------	-----------------------	-------

1-000-002-2-757	LX660-2007-T017/LxRx3	DYNAMIC
-----------------	-----------------------	---------

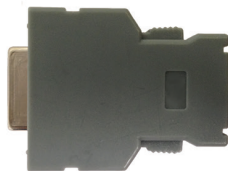

Reference Number <i>Codice Articolo</i>	Description <i>Descrizione</i>	Application <i>Applicazione</i>
--	-----------------------------------	------------------------------------

1-000-002-0-001	LX660-8932-D001	ACCESSORY
-----------------	-----------------	-----------

1-000-002-0-002	LX660-8932-D002	ACCESSORY
-----------------	-----------------	-----------

FANUC COMPATIBLE - ELECTRICAL CABINET CABLES

COMPATIBILE FANUC - CAVI per QUADRO ELETTRICO



Reference Number <i>Codice Articolo</i>	Description <i>Descrizione</i>	Application <i>Applicazione</i>
1-000-002-1-820	LX660-2077-T220/LxRx3	CABINET
1-000-002-1-821	LX660-2077-T221/LxRx3	CABINET
1-000-002-1-240	LX660-8077-T290/LxRx3	CABINET
1-000-002-1-292	LX660-8077-T342/LxRx3	CABINET
1-000-002-1-293	LX660-8077-T343/LxRx3	CABINET



Reference Number <i>Codice Articolo</i>	Description <i>Descrizione</i>	Application <i>Applicazione</i>
1-000-002-1-822	LX660-2077-T222/LxRx3	CABINET
1-000-002-1-823	LX660-2077-T223/LxRx3	CABINET
1-000-002-1-239	LX660-8077-T289/LxRx3	CABINET

FANUC COMPATIBLE - ELECTRICAL CABINET CABLES

COMPATIBILE FANUC - CAVI per QUADRO ELETTRICO



Reference Number
Codice Articolo

Description
Descrizione

Application
Applicazione

1-000-002-1-805

LX660-2077-T205/LxRx3

CABINET



Reference Number
Codice Articolo

Description
Descrizione

Application
Applicazione

1-000-002-1-808

LX660-2077-T208/LxRx3

CABINET



Reference Number
Codice Articolo

Description
Descrizione

Application
Applicazione

1-000-002-1-131

LX660-8007-T011/LxRx3

CABINET

FANUC COMPATIBLE - ELECTRICAL CABINET CABLES

COMPATIBILE FANUC - CAVI per QUADRO ELETTRICO



Reference Number <i>Codice Articolo</i>	Description <i>Descrizione</i>	Application <i>Applicazione</i>
1-000-002-1-405	LX660-8018-T005/LxRx3	CABINET
1-000-002-1-423	LX660-8018-T023/LxRx3	CABINET
1-000-002-1-182	LX660-8077-T232/LxRx3	CABINET
1-000-002-1-184	LX660-8077-T234/LxRx3	CABINET
1-000-002-1-185	LX660-8077-T235/LxRx3	CABINET
1-000-002-1-269	LX660-8077-T319/LxRx3	CABINET
1-000-002-1-271	LX660-8077-T321/LxRx3	CABINET



Reference Number <i>Codice Articolo</i>	Description <i>Descrizione</i>	Application <i>Applicazione</i>
1-000-002-1-769	LX660-2018-T009/LxRx3	CABINET
1-000-002-1-770	LX660-2018-T010/LxRx3	CABINET
1-000-002-1-440	LX660-8024-T010/LxRx3	CABINET
1-000-002-1-460	LX660-8030-T010/LxRx3	CABINET

FANUC COMPATIBLE - ELECTRICAL CABINET CABLES

COMPATIBILE FANUC - CAVI per QUADRO ELETTRICO



Reference Number <i>Codice Articolo</i>	Description <i>Descrizione</i>	Application <i>Applicazione</i>
1-000-002-1-355	LX660-8077-T405/LxRx3	CABINET
1-000-002-1-356	LX660-8077-T406/LxRx3	CABINET



Reference Number <i>Codice Articolo</i>	Description <i>Descrizione</i>	Application <i>Applicazione</i>
1-000-002-1-373	LX660-8078-T003/LxRx3	CABINET



Reference Number <i>Codice Articolo</i>	Description <i>Descrizione</i>	Application <i>Applicazione</i>
1-000-002-1-374	LX660-8078-T004/LxRx3	CABINET

FANUC COMPATIBLE - OPERATOR'S PANEL CABLES

COMPATIBILE FANUC - CAVI per PANNELLO OPERATORE

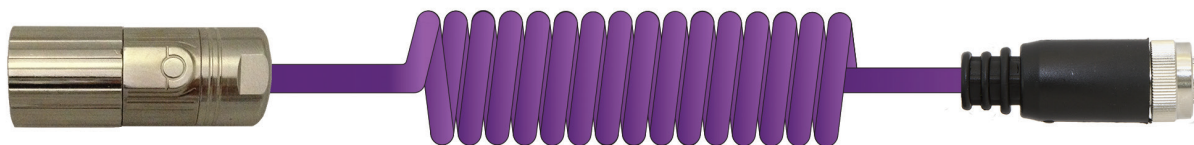

Reference Number <i>Codice Articolo</i>	Description <i>Descrizione</i>	Application <i>Applicazione</i>
1-000-002-2-943	LX660-4024-T023/LxRx3	HANDWHEEL
1-000-002-2-944	LX660-4024-T025/LxRx3	HANDWHEEL



Reference Number <i>Codice Articolo</i>	Description <i>Descrizione</i>	Application <i>Applicazione</i>
1-000-002-2-946	LX660-4024-T026/LxRx3	HANDWHEEL
1-000-002-2-947	LX660-4024-T027/LxRx3	HANDWHEEL
1-000-002-2-948	LX660-4024-T028/LxRx3	HANDWHEEL



Reference Number <i>Codice Articolo</i>	Description <i>Descrizione</i>	Application <i>Applicazione</i>
1-000-002-0-003	LX02B-0100-K026	ACCESSORY

FANUC COMPATIBLE - OPERATOR PANEL I/O

COMPATIBILE FANUC - I/O PANNELLO OPERATORE

Standard Version

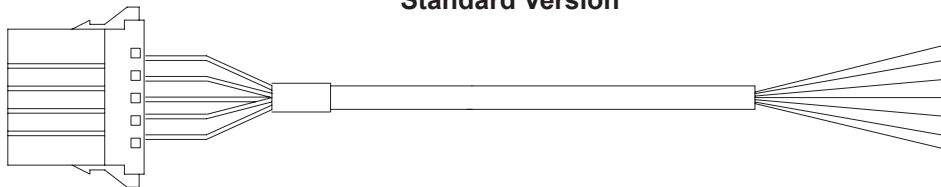

Reference Number
Codice Articolo

Description
Descrizione

Application
Applicazione

5-000-002-0-003

CM68 - CM69

I/O OPERATOR PANNEL

Terminal block Version

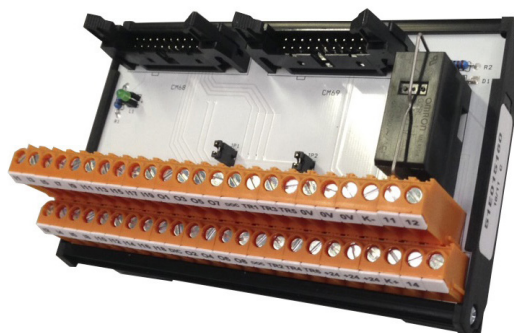
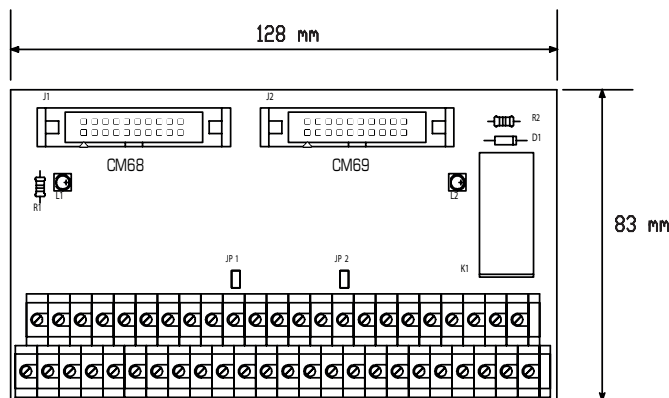

Reference Number
Codice Articolo

Description
Descrizione

Cable and terminal no salable separately
Cavo e morsettiera non vendibili separatamente

5-000-002-0-001

OPERATOR PANEL I/O
I/O PANNELLO OPERATORE

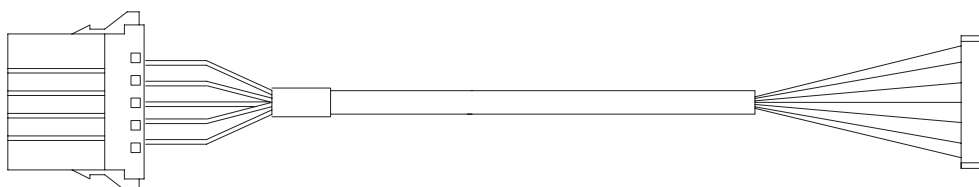

Reference Number
Codice Articolo

Description
Descrizione

Application
Applicazione

5-000-002-0-002

CM68 - CM69

I/O OPERATOR PANNEL



EUROCONNECTION

collegamenti di sistemi



EUROCONNECTION s.r.l.

Via Arduino Casale, 134 - 10010 Lessolo (TO) - Italy

Tel +39 (0)125 58 305

Fax +39 (0)125 58 894

info@euroconnection.it

www.euroconnection.it